

Panel mounted inlet - Part no. 831

- screw terminals
- nickel plated contacts
- a retaining nose to hold the hinged lid of the connector must be provided by the customer in order to ensure satisfactory locking

Protection type	IP 67
Ampere	32A
Poles	3p
Voltage	230V
Hertz	50-60Hz
Earth position	6h
Contact	standard
Connection technology	Screw terminals

Std. Pack. 10 Qty.

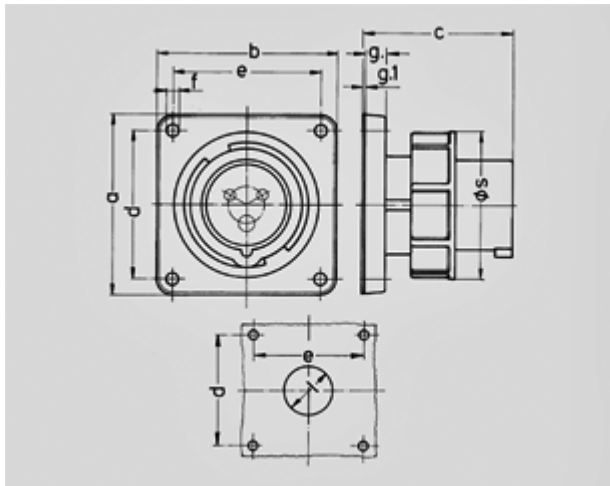

Drawing	Amp.	16			32		
		3	4	5	3	4	5
2 MB 187/2	Poles						
Dim. in mm	a	85,7	85,7	85,7	85,7	85,7	85,7
	b	85,7	85,7	85,7	85,7	85,7	85,7
	c	72	72	72	90	90	90
	d	69,5	69,5	69,5	69,5	69,5	69,5
	e	69,5	69,5	69,5	69,5	69,5	69,5
	f	5,5	5,5	5,5	5,5	5,5	5,5
	g.	11	11	11	11	11	11
	g.1	2	2	2	2	2	2
	l	32	36	47	47	47	47
	s	71	79	89	94	94	102
	Terminal for cond. cross section (mm ²) min.-max.	1,5	1,5	1,5	2,5	2,5	2,5
		-4	-4	-4	-10	-10	-10