

Wall mounted receptacle - Part no. 5643A

- screw terminals
- 63A: SoftCONTACT
- switched
- mechanical DUO-interlock
- DIN rail
- receptacles can be padlocked

Protection type	IP 67
Ampere	63A
Poles	5p
Voltage	400V
Hertz	50-60Hz
Earth position	6h
Contact	standard
Connection technology	Screw terminals

Std. Pack. 1 Qty.

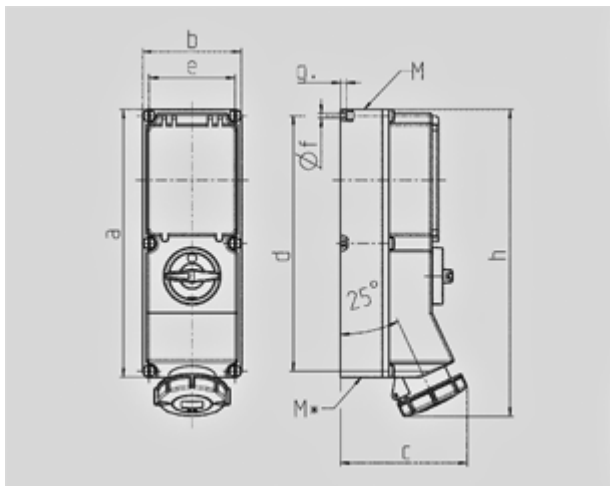

Drawing	Amp.	16			32		63	
		3	4	5	4	5	4	5
1 MB 181/620	Poles							
Dim. in mm	a	364	364	364	364	364	460	460
	b	134	134	134	134	134	180	180
	c	160	162	163	168	168	200	200
	d	347	347	347	347	347	440	440
	e	117	117	117	117	117	160	160
	f	6,3	6,3	6,3	6,3	6,3	8,1	8,1
	g	8	8	8	8	8	8	8
	h	391	395	398	408	411	200	200
	M	32/40	32/40	32/40	32/40	32/40	40	40
	M*	2x32	2x32	2x32	2x32	2x32	2x40	2x40
	Max. cable diam. (mm)	27	27	27	27	27	27	27
	Terminal for cond. cross section (mm ²) min.-max.	1,5	1,5	1,5	2,5	2,5	6	6
		-4	-4	-4	-10	-10	-25	-25