

Connector AM-TOP® - Part no. 540

- screw terminals
- single part body
- cable gland and sealing
- strain relief and protection against kinking

Protection type	IP 67
Ampere	16A
Poles	3p
Voltage	230V
Hertz	50-60Hz
Earth position	6h
Contact	standard
Connection technology	Screw terminals

Std. Pack. 10 Qty.

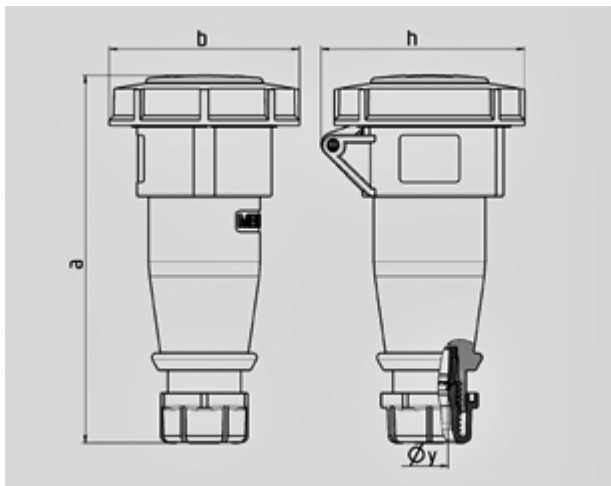

Drawing	Amp.	16			32		
		3	4	5	3	4	5
3 MB 62	Poles						
Dim. in mm	a	146	166	172	212	212	213
	b	72	79	89	96	96	102
	h	80	88	95	98	98	105
	y	14,5	16	16	22	22	22
Terminal for cond. cross		1	1	1	2,5	2,5	2,5
section (mm ²) min.-max.		-2,5	-2,5	-2,5	-6	-6	-6