

Cepex panel mounted receptacle - Part no. 4112

- screw terminals
- also suitable for installation in cable ducts and columns
- meeting DIN 18032 standards for ball rebound

Technical information

Ampere	16 A
Poles	3 p
Voltage	230V
Earth position	6 h
Hertz	50-60 Hz
Protection type	IP 44

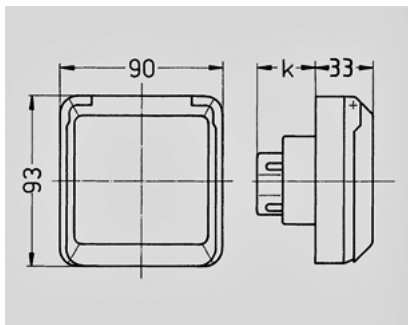

Drawing 1 MB 315	Amp. Poles	16			32		
		3	4	5	3	4	5
Dim. in mm	k	32	32	32	48	48	48
Terminal for cond. cross		1,5	1,5	1,5	2,5	2,5	2,5
section (mm²) min.-max.		-4	-4	-4	-6	-6	-6