

Cepex wall mounted receptacle - Part no. 4107

- screw terminals
- meeting DIN 18032 standards for ball rebound

Technical information

Ampere	32 A
Poles	3 p
Voltage	230V
Earth position	6 h
Hertz	50-60 Hz
Protection type	IP 44

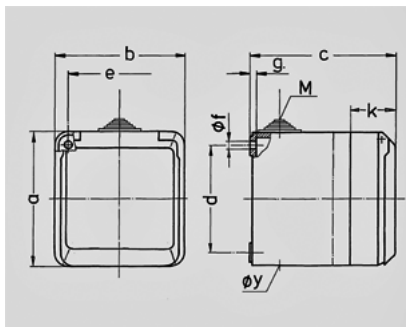

Drawing 1 MB 312	Amp. Poles	16			32		
		3	4	5	3	4	5
Dim. in mm	a	93	93	93	93	93	93
	b	90	90	90	90	90	90
	c	87	87	87	99	99	99
	d	75	75	75	75	75	75
	e	73	73	73	73	73	73
	f	5,5	5,5	5,5	5,5	5,5	5,5
	g	4,2	4,2	4,2	4,2	4,2	4,2
	k	33	33	33	33	33	33
	y	25,5	25,5	25,5	25,5	25,5	25,5
	M	25x1,5	25x1,5	25x1,5	25x1,5	25x1,5	25x1,5
Terminal for cond. cross section (mm ²) min.-max.		1,5	1,5	1,5	2,5	2,5	2,5
		-4	-4	-4	-6	-6	-6