

**Wall mounted inlet - Part no. 357**

- screw terminals
- for a suitable watertight protective cover for 63A see part no. 40434

Protection type	IP 67
Ampere	63A
Poles	4p
Voltage	400V
Hertz	50-60Hz
Earth position	6h
Contact	standard
Connection technology	Screw terminals

Std. Pack. 5 Qty.

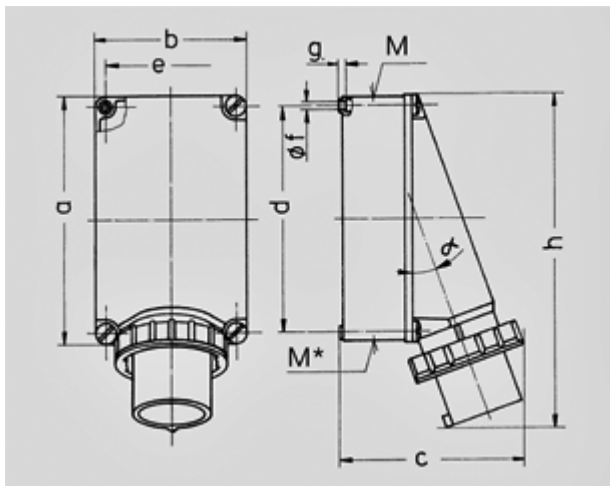

Drawing	Amp.	63			125	
		3	4	5	4	5
<b>2 MB 36</b>	<b>Poles</b>					
Dim. in mm	a	170	170	170	264	264
	b	118	118	118	163	163
	c	171	171	171	205	205
	d	136	136	136	240	240
	e	104	104	104	140	140
	f	6,1	6,1	6,1	8,1	8,1
	g	6	6	6	8	8
	h	250	250	250	355	355
	M	40	40	40	50	50
	M*	2x40	2x40	2x40	50	50
	alpha	25°	25°	25°	20°	20°
	Max. cable diam. (mm)	32	32	32	38	38
	Terminal for cond. cross section (mm <sup>2</sup> ) min.-max.	4	4	4	16	16
		-10	-10	-10	-35	-35