

Wall mounted inlet - Part no. 344

- screw terminals
- cable entry for 32A devices also possible on the back side
- enclosure base with stamped recess for quick cutting out

Protection type	IP 44
Ampere	32A
Poles	3p
Voltage	230V
Hertz	50-60Hz
Earth position	6h
Contact	standard
Connection technology	Screw terminals

Std. Pack. 10 Qty.

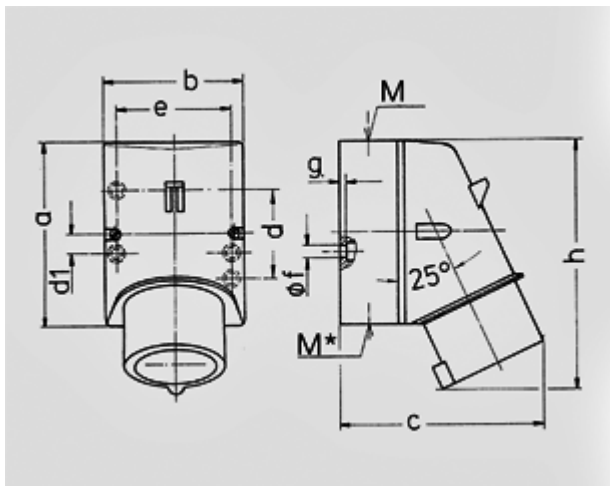

Drawing	Amp.	16			32		
		3	4	5	3	4	5
2 MB 32	Poles						
Dim. in mm	a	87	100	100	128	128	128
	b	64	75	75	84	84	84
	c	93	106	110	133	133	135
	d	40	—	—	—	—	—
	d1	—	10,5	10,5	11	11	11
	e	50,5	59	59	68	68	68
	f	4,5	5	5	5,3	5,3	5,3
	g	4	4	4	4	4	4
	h	122	133	135	169	169	170
	M	20	20	20	32	32	32
	M*	1x20 (blind) to be cut out			2x25 (blind) to be cut out		
	Max. cable diam. (mm)	15	15	15	18/25	18/25	18/25
	Terminal for cond. cross section (mm ²) min.-max.	1	1	1	2,5	2,5	2,5
		-2,5	-2,5	-2,5	-6	-6	-6