

Angled plug - Part no. 3266

- screw terminals
- nickel plated contacts
- with grommet

Protection type	IP 44
Ampere	32A
Poles	5p
Voltage	400V
Hertz	50-60Hz
Earth position	6h
Contact	nickel plated contacts
Connection technology	Screw terminals

Std. Pack. 10 Qty.

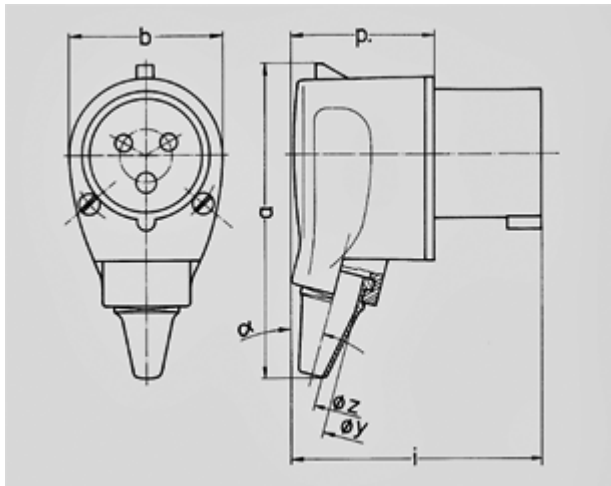

2 MB 69 2 MB 45	Amp. Poles	16		32		
		3	4	3	4	5
Dim. in mm	a	107	129	96	96	101
	b	53	58	72	72	72
	h	—	—	—	—	115
	i	85	71	115	115	—
	o	—	—	—	—	70
	p	49	35	70	70	—
	y	17,5	17,5	22	22	22
	z	7	7	11	11	11
	α	15°	—	8°	8°	—
Terminal for cond. cross		1	1	2,5	2,5	2,5
section (mm ²) min.-max.		-2,5	-2,5	-6	-6	-6