

**Panel mounted receptacle - Part no. 205A**

- screw terminals
- 63A: SoftCONTACT
- 125A: TorsionSpringCONTACT
- 20° inclination for 63A
- 15° inclination for 125A
- receptacles with pilot contact: part no. + index P

Protection type	IP 67
Ampere	63A
Poles	4p
Voltage	400V
Hertz	50-60Hz
Earth position	6h
Contact	standard
Connection technology	Screw terminals, SoftCONTACT

Std. Pack. 5 Qty.

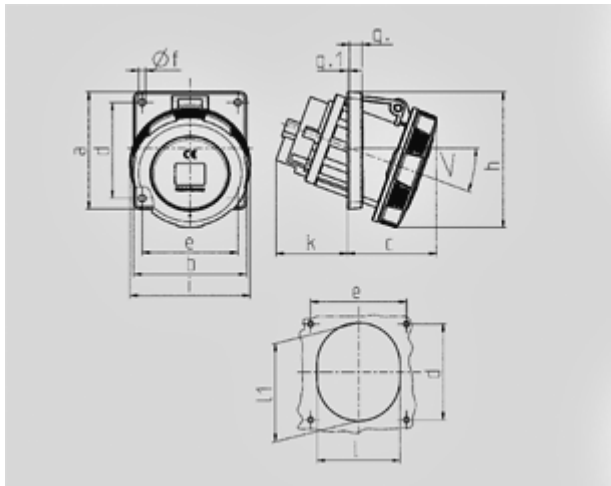

1 MB 298 1 MB 601 Dim. in mm	Amp. Poles	63			125		
		3	4	5	3	4	5
a		110	110	110	114	114	114
b		106	106	106	110	110	110
c		85	85	85	75	75	75
d		85	85	85	90	90	90
e		77	77	77	90	90	90
f		6,2	6,2	6,2	6,2	6,2	6,2
g		12	12	12	13	13	13
g.1		2	2	2	2	2	2
h		128	128	128	133	133	133
i		113	113	113	126	126	126
k		67	67	67	103	103	103
l		92	92	92	94	94	94
ll		98	98	98	107	107	107
<		20°	20°	20°	15°	15°	15°
Terminal for cond. cross section (mm²) min.-max.		6 -25	6 -25	6 -25	25 70	25 70	25 70