

Panel mounted inlet - Part no. 1983

- screw terminals
- with highly heat resistant contact carrier
- nickel plated contacts
- 63A: a retaining nose to hold the hinged lid of the connector must be provided by the customer in order to ensure satisfactory locking

Protection type	IP 67
Ampere	125A
Poles	5p
Voltage	400V
Hertz	50-60Hz
Earth position	6h
Contact	nickel plated contacts, highly heat resistant contact carrier
Connection technology	Screw terminals

Std. Pack. 5 Qty.

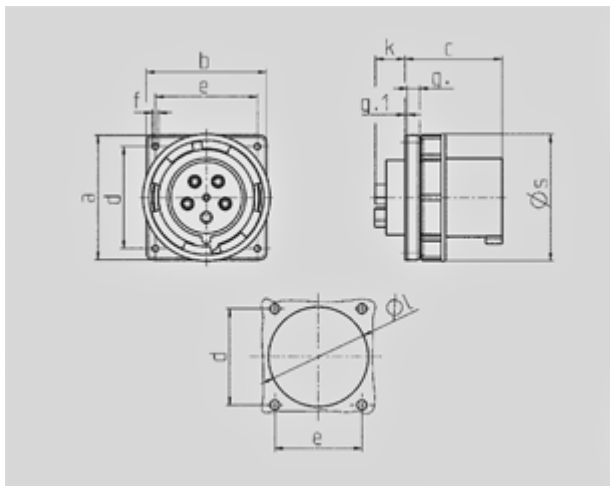

Drawing	Amp.	63			125		
		3	4	5	3	4	5
2 MB 166	Poles						
Dim. in mm	a	110	110	110	130	130	130
	b	106	106	106	130	130	130
	c	86	86	86	112	112	112
	d	90	90	90	104	104	104
	e	90	90	90	104	104	104
	f	5,5	5,5	5,5	6,5	6,5	6,5
	g.	12	12	12	18	18	18
	g.1	2	2	2	2	2	2
	k	28	28	28	28	28	28
	l	88.5	88.5	88.5	95	95	95
	s	113	113	113	132	132	132
	Terminal for cond. cross section (mm ²) min.-max.	6	6	6	25	25	25
		-16	-16	-16	-70	-70	-70