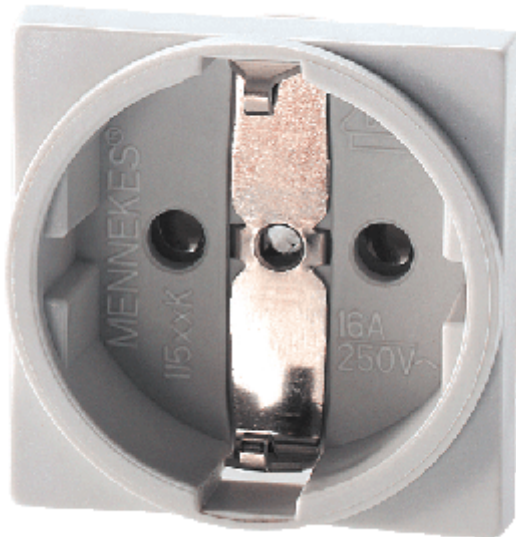
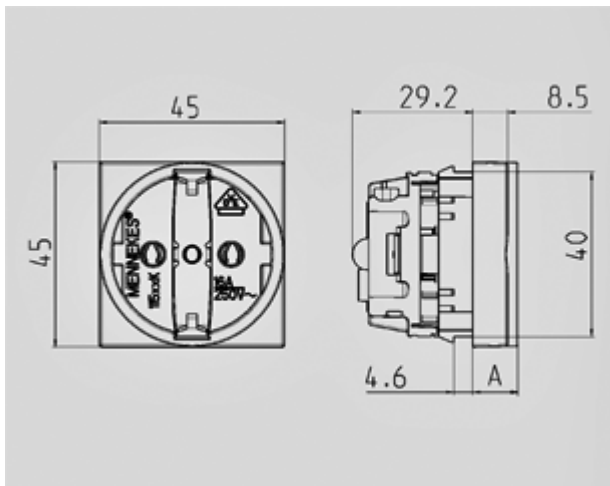

**Snap-in receptacle SCHUKO® - Part no. 11510K**

- without hinged lid
- with 3 plug-in terminals for connection of 1.5 – 2.5 mm<sup>2</sup>
- for easy installation in a cable duct or an enclosure
- for fixing on DIN rail with fixing rack 11254

Protection type	IP 20
Ampere	16A
Voltage	230V
Contact	standard
Connection technology	Plug-in terminals

Std. Pack. 10 Qty.

Drawing  
1 MB 457

Dim. in mm