

**Connector SCHUKO® - Part no. 10843**

- screw terminals
- with grommet and lid
- for cables up to 3 x 2.5 mm<sup>2</sup>, up to H07RN-F



## Technical information

Ampere	16 A
Poles	2 p+E
Voltage	230V
Shutter	no
Connection technology	Screw terminals
Contact	standard
Protection type	IP 44

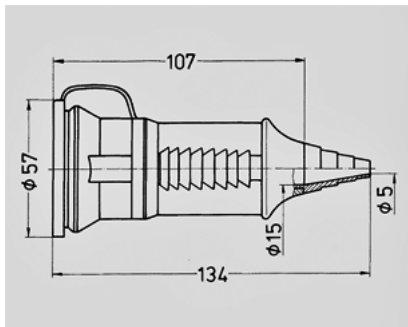
Drawing  
3 MB 39

Dim. in mm